

Thank you for purchasing a Sealey product. Manufactured to a high standard this product will, if used according to these instructions and properly maintained, give you years of trouble free performance.

IMPORTANT: PLEASE READ THESE INSTRUCTIONS CAREFULLY. NOTE THE SAFE OPERATIONAL REQUIREMENTS, WARNINGS & CAUTIONS. USE THE PRODUCT CORRECTLY AND WITH CARE FOR THE PURPOSE FOR WHICH IT IS INTENDED. FAILURE TO DO SO MAY CAUSE DAMAGE AND/OR PERSONAL INJURY AND WILL INVALIDATE THE WARRANTY. PLEASE KEEP INSTRUCTIONS SAFE FOR FUTURE USE.

1. SAFETY INSTRUCTIONS

- ✓ Familiarise yourself with the application, limitations and potential hazards of the puller.
 - ❑ **WARNING! Pullers are not designed or certificated for lifting or slinging loads. They are intended only as pulling/tensioning devices and must only be used as such, and with care.**
 - ✓ Ensure the puller is maintained in a safe working condition. Inspect the cable regularly. Check for fraying, kinks, broken strands or distortion. If any fault is found, replace the cable using a genuine replacement from your authorised service agent. Check all component parts, do not use if damaged but contact an authorised service agent.
 - ❑ **WARNING! Ensure you know how much load you are pulling. Never exceed the maximum pulling capacity. Take into account any angle of incline over which the load must be pulled. Also account for pulling loads from thick mud, or through snow or water. Chock the wheels of vehicles to be winched and only then release any brakes and place gears in neutral. Ensure the load is capable of free movement before pulling. Take up the strain on the puller before removing the wheel chocks from a vehicle.**
 - ✓ If necessary fit an adequate sling, eyebolt or other accessory to the load. Ensure that accessories are equal to, or exceed maximum capacity of puller.
 - ✓ Maintain correct balance and footing whilst using the puller.
 - ✓ Remove ill fitting clothing. Remove ties, watches, rings and other loose jewellery and contain and/or tie back long hair.
 - ✓ Wear appropriate safety clothing, gloves and eye protection.
 - ✓ Keep children and non-essential persons away from the operating area. Be aware of the location of other persons assisting you.
 - ✓ Take necessary precautions for your personal safety whilst using the puller.
 - x DO NOT operate the puller if any parts are damaged or missing as this may cause failure and/or personal injury.
 - x DO NOT feed the rope from the rear of the puller.
 - x DO NOT operate the release lever while the puller is under load.
 - x DO NOT operate both levers at the same time.
 - x DO NOT work behind a load that is under tension, always use additional methods to secure load.
 - ❑ **WARNING! DO NOT exceed the maximum pulling capacity.**
 - ❑ **WARNING! DO NOT use the puller as a lifting device. DO NOT use the puller for any purpose other than that for which it is designed.**
 - x DO NOT pull the cable over or around a corner.
 - x DO NOT wrap cable around any object or hook the cable back on to itself.
 - ▲ **DANGER! DO NOT use a "cheater" pipe, lever, or other device to lengthen the handle for additional leverage, as the puller may fail, causing damage and/or personal injury.**
 - x DO NOT operate the puller if you are tired or under the influence of alcohol, drugs or intoxicating medication.
 - x DO NOT move the handle abruptly when releasing the tension from the load.
- NOTE: Use caution when carrying these pullers as the units are heavy.**
- ✓ Keep the puller clean and store in a safe, dry, childproof location when not in use.

2. INTRODUCTION & SPECIFICATIONS



These hand operated pullers are ideal for moving vehicles, logs, machines and other heavy objects. All models feature two levers for extra control when pulling or releasing load. Added quick release lever saves time when tightening the rope to required length. All units are GS/TUV approved. Supplied with removable lever handle and 20m of wire rope with heavy-duty hook.

SPECIFICATIONS

Model:	WRP800	WRP1600	WRP3200
Pulling capacity	.800kg	.1600kg	.3200kg
Wire rope Ø	.8.3mm	.11mm	.16mm
Wire rope length	.20m	.20m	.20m
Weight	.6.4kg	.12kg	.23kg



Note: Pulling capacity is given as a rolling load on a level surface. Exercise extreme caution and do not overload, particularly on "deadweight" loads.

3. OPERATING INSTRUCTIONS

- ❑ **WARNING!** Ensure that you read, understand and apply Section 1 Safety Instructions before using the puller.
- ❑ **WARNING!** Before every use thoroughly inspect EVERY part of the wire puller for signs of damage or stress. If any are found do not use but refer to an authorised repair agent for all repairs. Do not use the wire rope if there is any evidence of fraying, stress or other damage. Do not kink the wire rope.

3.1. ATTACHING PULLER TO LOAD AND ANCHOR

- 3.1.1 Pass the anchor pin through the puller body (fig.1). When it is as far as it can go rotate through a further 180° and insert fully home. A 'D' pin (not supplied) may be pushed through the anchor pin to provide additional security.
- 3.1.2 Attach the puller to a suitable anchor point, ensuring that it is capable of withstanding the maximum line pull, check any chains, strops or shackles to ensure they are rated equal to or exceeding the maximum line pull. Do not wrap the wire rope back on itself.

3.2 INSERTING WIRE ROPE.

- 3.2.1 Place forward and reverse levers away from the release lever. Push the release lever into the locked position as shown in fig 2.2, this allows the internal jaws to open, enabling the wire rope to be inserted through the wire feed (fig 2.1).

Note: *The release lever can be difficult to lock into place, it requires firm pressure downwards onto it (the forward and reverse levers will be seen to move out), before also pushing forwards to lock it into place. This is best carried out with the puller tipped up at an angle (see fig.3).*

- 3.2.2 Insert the wire rope through the feed (fig 2.1). Direct the wire rope out of the back and run above the anchor pin.
- 3.2.3 Take up slack by pulling the cable through the puller. When the slack has been taken up unlock the release lever by pushing down and back. The puller is now ready for use.

3.3 OPERATION

3.3.1 PULLING A LOAD

- 3.3.2 To pull a load, ensure the wire rope is firmly attached to the load to be pulled and the puller is anchored to a suitable position.
- 3.3.3 Lock the handle onto the forward lever (fig 2.4) by locating the pin and twisting through 180°.
- 3.3.4 Moving the handle back and forth will pull the wire rope through the puller.

NOTE: *As an added safety feature the forward lever is fitted with a shear pin. If the load is greater than the capacity of the puller the pin will shear. The pin will require replacing with part No. WRP800.16, WRP1600.16 or WRP3200.16.*

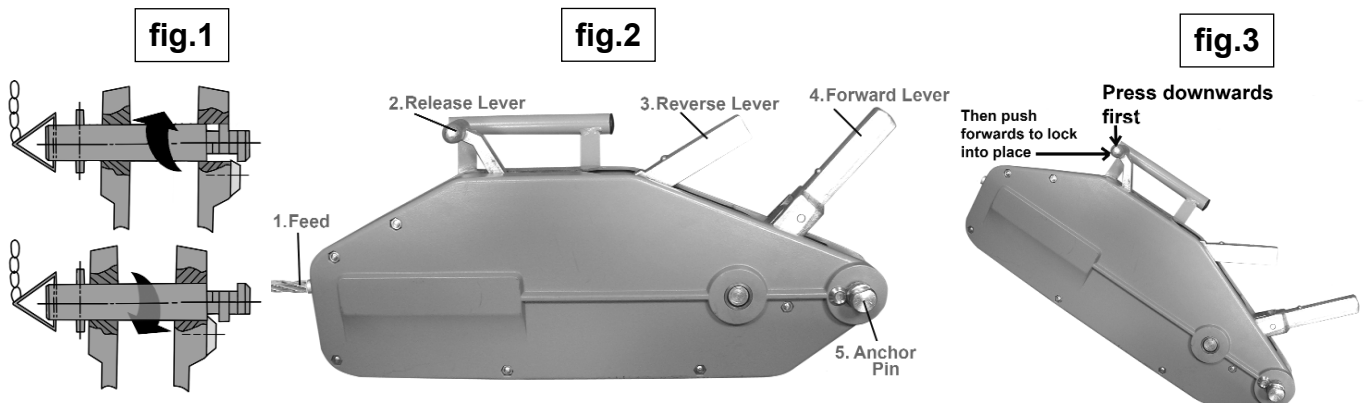

3.4 LOWERING A LOAD



- 3.4.1 To lower a load, lock the handle onto the reverse lever (fig 2.3), by locating the pin and twisting through 180°.
- 3.4.2 Moving the handle back and forth will push the wire rope back through the puller.
- 3.4.3 When all load has been removed from the puller, move the release lever back into the locked position (see 3.2.1.above) and withdraw the wire rope from the puller.
- 3.4.4 Wind the wire rope back onto its reel, take this opportunity to inspect the rope for any damage that may have occurred during the pulling procedure. Unlock the release lever on the puller, if not being used, store away in a safe, dry, childproof location

4. MAINTENANCE

4.1. CLEANING

Clean the puller after each use and wipe with a slightly oiled cloth. Store in a safe, dry, childproof location.

5. DECLARATION OF CONFORMITY





WIRE ROPE PULLERS Models WRP800, WRP1600, WRP3200 98/37/EC Machinery Directive 93/68/EEC CE Marking Directive	Declaration of Conformity We, the sole importer into the UK, declare that the products listed here are in conformity with the following standards and directives.  The construction files for these products are held by the Manufacturer and may be inspected, by a national authority, upon request to Jack Sealey Ltd. Signed by Mark Sweetman  18th August 2006 For Jack Sealey Ltd. Sole importer into the UK of Sealey Power Products.
--	--

NOTE: *It is our policy to continually improve products and as such we reserve the right to alter data, specifications and component parts without prior notice.*

IMPORTANT: No liability is accepted for incorrect use of this product.

WARRANTY: Guarantee is 12 months from purchase date, proof of which will be required for any claim.

INFORMATION: For a copy of our catalogue and latest promotions call us on 01284 757525 and leave your full name, address and postcode.

	Sole UK Distributor Sealey Group, Bury St. Edmunds, Suffolk.	 01284 757500  01284 703534	 www.sealey.co.uk  sales@sealey.co.uk
---	--	--	--