

**DRAPER**<sup>®</sup>

**STORMFORCE**

INSTRUCTIONS FOR  
**18V Li-ion  
Cordless Rotary Drill**

Stock No.14600 Part No.CD18LISF

**IMPORTANT:** PLEASE READ THESE INSTRUCTIONS CAREFULLY TO ENSURE THE SAFE AND EFFECTIVE USE OF THIS PRODUCT.



CE

**DRAPER**<sup>®</sup>

## GENERAL INFORMATION

These instructions accompanying the product are the original instructions. This document is part of the product, keep it for the life of the product passing it on to any subsequent holder of the product. Read all these instructions before assembling, operating or maintaining this product.

This manual has been compiled by Draper Tools describing the purpose for which the product has been designed, and contains all the necessary information to ensure its correct and safe use. By following all the general safety instructions contained in this manual, it will ensure both product and operator safety, together with longer life of the product itself.

All photographs and drawings in this manual are supplied by Draper Tools to help illustrate the operation of the product.

Whilst every effort has been made to ensure the accuracy of information contained in this manual, the Draper Tools policy of continuous improvement determines the right to make modifications without prior warning.

# 1. TITLE PAGE

---

## **1.1 INTRODUCTION:**

USER MANUAL FOR:

## **18V LI-ION CORDLESS ROTARY DRILL**

Stock no. 14600

Part no. CD18LISF

## **1.2 REVISIONS:**

\_\_\_\_\_  
Date first published June 2016  
\_\_\_\_\_  
\_\_\_\_\_  
\_\_\_\_\_

As our user manuals are continually updated, users should make sure that they use the very latest version.

Downloads are available from: <http://www.drapertools.com/manuals>

DRAPER TOOLS LIMITED

HURSLEY ROAD

CHANDLER'S FORD

EASTLEIGH

HAMPSHIRE

SO53 1YF

UK

WEBSITE: [drapertools.com](http://drapertools.com)

PRODUCT HELP LINE: +44 (0) 23 8049 4344

GENERAL FAX: +44 (0) 23 8026 0784

## **1.3 UNDERSTANDING THIS MANUALS SAFETY CONTENT:**

**WARNING!** Information that draws attention to the risk of injury or death.

**CAUTION!** Information that draws attention to the risk of damage to the product or surroundings.

## **1.4 COPYRIGHT © NOTICE:**

Copyright © Draper Tools Limited.

Permission is granted to reproduce this publication for personal & educational use only. Commercial copying, redistribution, hiring or lending is prohibited.

No part of this publication may be stored in a retrieval system or transmitted in any other form or means without written permission from Draper Tools Limited.

In all cases this copyright notice must remain intact.

---

# 2. CONTENTS

---

## 2.1 CONTENTS

	<b>PAGE</b>	<b>CONTENT</b>	<b>PAGE</b>
1		TITLE PAGE	
	1.1	INTRODUCTION .....	2
	1.2	REVISION HISTORY .....	2
	1.3	UNDERSTANDING THIS MANUAL .....	2
	1.4	COPYRIGHT NOTICE .....	2
2		CONTENTS	
	2.1	CONTENTS .....	3
3		GUARANTEE	
	3.1	GUARANTEE .....	4
4		INTRODUCTION	
	4.1	SCOPE .....	5
	4.2	SPECIFICATION .....	5
	4.3	HANDLING & STORAGE .....	5
5		HEALTH & SAFETY INFORMATION	
	5.1	GENERAL SAFETY INSTRUCTIONS .....	6
	5.2	GENERAL INSTRUCTIONS FOR BATTERY POWERED TOOLS & CHARGERS.....	7
	5.3	SAFETY INSTRUCTIONS FOR MAINS POWERED BATTERY PACK CHARGERS .....	7
	5.4	INSTRUCTIONS FOR DRILLS, CHARGERS AND BATTERIES .....	8
	5.5	CONNECTION TO THE POWER SUPPLY .....	8
	5.6	LITHIUM ION DATA SHEET .....	8
6		TECHNICAL DESCRIPTION	
	6.1	IDENTIFICATION .....	9
7		UNPACKING & CHECKING	
	7.1	PACKAGING .....	10
	7.2	WHAT'S IN THE BOX .....	10
8		BASIC CORDLESS ROTARY DRILL OPERATIONS	
	8.1	BATTERY CHARGING .....	11
	8.2	DUST AND SWarf .....	11
	8.3	INSTALLING AND REMOVING BITS .....	12
	8.4	LED WORK LIGHT .....	12
	8.5	FORWARD/REVERSE SELECTOR .....	12
	8.6	VARIABLE SPEED TRIGGER.....	12
	8.7	TORQUE CONTROL.....	13
	8.8	HOLDING THE DRILL .....	14
	8.9	DRILLING WOOD AND PLASTIC.....	14
	8.10	DRILLING METAL .....	14
	8.11	SCREWDRIVING .....	14
9		MAINTENANCE	
	9.1	MAINTENANCE .....	15
10		OPTIONAL ACCESSORIES	
	10.1	OPTIONAL ACCESSORIES .....	16
11		TROUBLESHOOTING .....	17
12		EXPLANATION OF SYMBOLS	
	12.1	EXPLANATION OF SYMBOLS .....	18
13		DISPOSAL	
	13.1	DISPOSAL .....	19
	13.2	HEALTH AND SAFETY FOR BATTERIES .....	19
	13.3	DISPOSAL .....	19
		DECLARATION OF CONFORMITY .....	ENCLOSED

## 3. GUARANTEE

---

### **3.1 GUARANTEE**

Draper tools have been carefully tested and inspected before shipment and are guaranteed to be free from defective materials and workmanship.

Should the tool develop a fault, please return the complete tool to your nearest distributor or contact Draper Tools Limited, Chandler's Ford, Eastleigh, Hampshire, SO53 1YF. England. Telephone Sales Desk: (023) 8049 4333 or Product Help Line (023) 8049 4344.

A proof of purchase must be provided with the tool.

If upon inspection it is found that the fault occurring is due to defective materials or workmanship, repairs will be carried out free of charge. This guarantee period covering parts/labour is 12 months from the date of purchase except where tools are hired out when the guarantee period is 90 days from the date of purchase. The guarantee is extended to 24 months for parts only. This guarantee does not apply to normal wear and tear, nor does it cover any damage caused by misuse, careless or unsafe handling, alterations, accidents, or repairs attempted or made by any personnel other than the authorised Draper warranty repair agent.

Note: If the tool is found not to be within the terms of warranty, repairs and carriage charges will be quoted and made accordingly.

This guarantee applies in lieu of any other guarantee expressed or implied and variations of its terms are not authorised.

Your Draper guarantee is not effective unless you can produce upon request a dated receipt or invoice to verify your proof of purchase within the guarantee period.

Please note that this guarantee is an additional benefit and does not affect your statutory rights.

Draper Tools Limited.

## 4. INTRODUCTION

---

### 4.1 SCOPE

This cordless drill is designed for use with a variety of drill bits, intended for drilling holes in wood, plastic, metal, etc. It is intended for domestic and light commercial use only.

Any other application is considered misuse.

### 4.2 SPECIFICATION

Stock No..... 14600

Part No..... CD18LISF

#### Battery:

Type ..... Li-ion

Rated Voltage ..... 18V

Rating ..... 1.5Ah

#### Charger:

Rated Voltage ..... 230V~

Rated Frequency ..... 50Hz

Rated Power Input ..... 12W

Rated D.C. Output Voltage ..... 22V DC

Rated D.C. Output Current ..... 350mAh

Construction ..... Class II

#### Drill Capacities:

Wood ..... 25mm

Mild Steel ..... 10mm

Maximum Torque ..... 25Nm

Revolutions Per Minute (no load) ..... 0-700min<sup>-1</sup>

Chuck Capacity ..... 10mm

Spindle Thread ..... 3/8 x 24unf

Sound Pressure Level ..... 85.3dB(A)

Sound Power Level ..... 96.3dB(A)

Vibration Level ..... 1.0m/s<sup>2</sup>

Weight (drill and battery)..... 0.70kg

### 4.3 HANDLING & STORAGE

Although this machine is small in size, care must still be taken when handling and lifting.

Dropping this machine will have an effect on the accuracy and may also result in personal injury. This machine is not a toy and must be respected.

The environment will have a negative result on its operation if you are not careful. If the air is damp, components will rust. If the machine is unprotected from dust and debris; components will become clogged: And if not cleaned and maintained correctly or regularly the machine will not perform at its best.

# 5. HEALTH & SAFETY INFORMATION

## 5.1 GENERAL SAFETY INSTRUCTIONS

### General Power Tools Safety Warnings

**⚠️ WARNING:** Read all instructions. Failure to follow all instructions listed below may result in electric shock, fire and/or serious injury.

Save all warnings and instructions for future reference.

The term "power tool" in the warnings refers to your mains operated (corded) power tool or battery operated (cordless) power tool.

#### 1) Work area safety

- Keep work area clean and well lit.** Cluttered or dark areas invite accidents.
- Do not operate power tools in explosive atmospheres, such as in the presence of flammable liquids, gases or dust.** Power tools create sparks which may ignite the dust or fumes.
- Keep children and bystanders away while operating a power tool.** Distractions can cause you to lose control.

#### 2) Electrical Safety

- Power tool plugs must match the outlet.** Never modify the plug in any way. Do not use any adapter plugs with earthed (grounded) power tools. Unmodified plugs and matching outlets will reduce risk of electrical shock.
- Avoid body contact with earthed or grounded surfaces such as pipes, radiators, ranges and refrigerators.** There is an increased risk of electric shock if your body is earthed or grounded.
- Do not expose power tools to rain or wet conditions.** Water entering a power tool will increase the risk of electric shock.
- Do not abuse the cord.** Never use the cord for carrying, pulling or unplugging the power tool. Keep cord away from heat, oil, sharp edges or moving parts. Damaged or entangled cords increase the risk of electric shock.
- When operating a power tool outdoors, use an extension cord suitable for outdoor use.** Use of cord suitable for outdoor use reduces the risk of electric shock.
- If operating a power tool in a damp location is unavoidable, use a residual current device (RCD) protected supply.** Use of an RCD reduces the risk of electric shock.

#### 3) Personal Safety

- Stay alert, watch what you are doing and use common sense when operating a power tool. Do not use a power tool while you are tired or under the influence of drugs, alcohol or medication.** A moment of inattention while operating power tools may result in serious personal injury.
- Use personal protective equipment. Always wear eye protection.** Protective equipment such as dust mask, nonskid safety shoes, hard hat, or hearing protection used for appropriate conditions will reduce personal injuries.
- Prevent unintentional starting. Ensure the switch is in the off position before connecting to power source and/or battery pack, picking up or carrying the tool.** Carrying power tools with your finger on the switch or energising power tools that have the switch on invites accidents.
- Remove any adjusting key or wrench before turning the power tool on.** A wrench or a key left attached to a rotating part of the power tool may result in personal injury.

- Do not overreach. Keep proper footing and balance at all times.** This enables better control of the power tool in unexpected situations.
- Dress properly. Do not wear loose clothing or jewellery. Keep your hair, clothing and gloves away from moving parts.** Loose clothes, jewellery or long hair can be caught in moving parts.
- If devices are provided for the connection of dust extraction and collection facilities, ensure these are connected and properly used.** Use of dust collection can reduce dust related hazards.

#### 4) Power Tool Use And Care

- Do not force the power tool. Use the correct power tool for your application.** The correct power tool will do the job better and safer at the rate for which it was designed.
- Do not use the power tool if the switch does not turn it on and off.** Any power tool that cannot be controlled with the switch is dangerous and must be repaired.
- Disconnect the plug from the power source and/or the battery pack from the power tool before making any adjustments, changing accessories, or storing power tools.** Such preventive safety measures reduce the risk of starting the power tool accidentally.
- Store idle power tools out of the reach of children and do not allow persons unfamiliar with the power tool or these instructions to operate the power tool.** Power tools are dangerous in the hands of untrained users.
- Maintain power tools. Check for misalignment or binding of moving parts, breakage of parts and any other condition that may affect the power tools operation. If damaged, have the power tool repaired before use.** Many accidents are caused by poorly maintained power tools.
- Keep cutting tools sharp and clean.** Properly maintained cutting tools with sharp cutting edges are less likely to bind and are easier to control.
- Use the power tool, accessories and tool bits etc., in accordance with these instructions, taking into account the working conditions and the work to be performed.** Use of the power tool for operations different from intended could result in a hazardous situation.

#### 5) Battery tool use and care

- Recharge only with the charger specified by the manufacturer.** A charger that is suitable for one type of battery pack may create a risk of fire when used with another battery pack.
- Use power tools only with specifically designated battery packs.** Use of any other battery packs may create a risk of injury and fire.
- When battery pack is not in use, keep it away from other metal objects, like paper clips, coins, keys, nails, screws or other small metal objects, that can make a connection from one terminal to another.** Shorting the battery terminals together may cause burns or a fire.
- Under abusive conditions, liquid may be ejected from the battery; avoid contact.** If contact accidentally occurs, flush with water. If liquid contacts eyes, additionally seek medical help. Liquid ejected from the battery may cause irritation or burns.

#### 6) Service

- Have your power tool serviced by a qualified repair person using only identical replacement parts.** This will ensure that the safety of the power tool is maintained.

# 5. HEALTH & SAFETY INFORMATION

## 5.2 GENERAL INSTRUCTIONS FOR BATTERY POWERED TOOLS & CHARGERS

### Good Working Practices/Safety

The following suggestions will enable you to observe good working practices, keep yourself and fellow workers safe and maintain your tools and equipment in good working order.

### WARNING!! LEAKING BATTERY PACKS

 The electrolyte in the battery packs is corrosive, if a battery pack is damaged and leaking, avoid contact with the skin; if contact is made, flush the area with running water, pat dry and seek medical attention and advice at the earliest opportunity, inform the medical service that the contaminant was a "high alkaline, corrosive liquid". If the electrolyte comes into contact with the eyes, flush with copious amounts of water only, seek medical attention immediately, relaying the information above.

### WARNING!! KEEP TOOLS AND EQUIPMENT OUT OF THE REACH OF YOUNG CHILDREN

#### Battery Powered Tools

#### Workplace/Environment

Under no circumstances should CHILDREN be allowed in work areas.

It is good practice to leave the tool and the battery pack separated until work is about to commence; if this is not practical do not carry tools around with fingers near the trigger switch, and engage the stop-lock of the tool if one is available. It is preferable to move small tools e.g. drills and jigsaws to the work area in their carrying/storage cases; if this is not possible it is advisable that you do not mount the blades or drill bits into the tool until you reach the work area (they make effective stabbing tools if you trip or stumble).

If you are working from ladders or towers, ensure they are securely fixed/braced, and always maintain a balanced, comfortable working posture; do not over-reach, or perform simian agility exercises to get the work done, the extra time required to move the ladder or tower is a good trade off against injuries sustained from a fall. Similarly nonslip footwear and nonslip surfaces are a good investment.

If the work you are carrying out is liable to generate flying grit, dust, swarf or chips, wear the appropriate safety clothing, goggles, gloves, masks etc - if the work operation appears to be excessively noisy, wear ear-defenders. If you wear your hair in a long style, wearing a cap, safety helmet, hairnet, even a sweatband, will minimise the possibility of your hair being caught up in the rotating parts of the tool, likewise, consideration should be given to the removal of rings and wristwatches, if these are liable to be a hazard.

Do not work with cutting tools of any description if you are tired, your attention is wandering or you are being subjected to distraction. A deep cut, a lost finger tip or worse, is not worth it!

Do not use the tools within the designated safety areas of flammable liquid stores or in areas where there may be volatile gases. There are very expensive, very specialised tools for working in these areas, THESE ARE NOT THE TOOLS FOR THESE AREAS.

Do not discard old batteries, or old cutting tools of any description, into general rubbish; the cutting tools may still be sharp enough to inflict an injury, and old batteries if overheated or are part of rubbish that is to be disposed of by burning, are an explosion hazard. Similarly, do not dispose of old battery packs into clean water run-offs; if they eventually leak, they will become a pollutant hazard.

Check that cutting tools are undamaged and are kept clean and sharp, this will maintain their operating performance and lessen the loading on the tool. If possible, always use clamps or a vice to hold your work. Do not put pressure on the drill, such that it slows the motor down. Allow the drill bit to drill without pressure. You will get better results and you will be taking better care of your tool.

Keep the area free of tripping hazards

Do not touch the bit after operation. It will be very hot.

## 5.3 SAFETY INSTRUCTIONS FOR MAINS POWERED BATTERY PACK CHARGERS

1. The charger is for INDOOR use only.
2. Prior to plugging the charger in to the supply, check that the plug and the cable are in good repair. If either are damaged, have the defective item replaced immediately by a suitably qualified person. If the casing of the battery charger is damaged, it is good policy to have the charger checked over by a suitably qualified person.
3. Only use a correctly rated mains outlet to provide power, do not plug into site generators, attach to engine generators or D.C. sources. Do not use a mains socket outlet that is not switched.
4. Only use the charger that was supplied with the battery pack, and vice versa.
5. Do not attempt to charge battery packs that are too hot (over 40°C) or too cold (under 5°C); if these conditions apply set the battery aside to "normalise" before proceeding with the charging operation.
6. Set up the charger and cable in a safe place where it won't be knocked, tripped over, stepped on, etc. and where it is well ventilated; make sure the ventilation slots in the charger case are not obstructed, plug the charger into the socket outlet.
7. Inspect the battery pack for damage; if it is undamaged, plug it into the charger, ensuring the correct orientation. (Most chargers and batteries have 'keys' etc, to make sure the battery is not inserted incorrectly, if you are having to 'force' the battery into the charger, the chances are you have it the wrong way round, check and try again.)
8. Switch the charger on and check that the correct indicators illuminate, allow the battery pack to charge (see the specific instructions for your charger). Once charging is complete, switch the charger off, remove the battery pack and store, repeat the procedure if you have more than one battery to charge. Note that some RAPID chargers require a "rest" period between charges, read the instruction manual concerning your specific charger to see if this is the case. After charging is complete, unplug the charger from the socket outlet by pulling on the plug. Do not pull on the cable. Store the charger in a dry secure place.
9. If, when the charger was switched on, the correct indications did not occur, leave for two or three minutes to allow the charger to stabilise; if the correct indications occur, allow the charging cycle to proceed as normal. If no indication appears at all, switch off, remove the battery pack, unplug the charger, check that the charger contacts and the battery contacts are clean and repeat the process; if there is still no indication, switch off, remove the battery pack, unplug the charger and check the fuse. If the fuse is blown, replace and repeat the process; if the fuse blows again, or if the fuse was intact, attempt no further action. Refer the charger to a suitably qualified person for assessment/repair.

## 5. HEALTH & SAFETY INFORMATION

---

### 5.4 INSTRUCTIONS FOR DRILLS, CHARGERS AND BATTERIES.

#### 1) Drills and Impact Drills

- a) **Wear ear protectors with impact drills.**  
Exposure to noise can cause hearing loss.

#### 2) Battery Chargers

- a) **Before charging, read the instructions.**
- b) **For indoor use.** Do not expose to rain.
- c) **Do not charge non-rechargeable batteries.**
- d) **The battery charger is only suitable for charging rechargeable Draper 18V Li-ion batteries.**  
Any other application is considered misuse.

#### 3) Battery

- a) **The battery must be removed from the appliance before it is scrapped.**
- b) **The appliance must be disconnected from the supply mains when removing the battery.**
- c) **The battery is to be disposed of safely.**
- d) **Do not use non-rechargeable batteries.**
- e) **Do not crush, open or burn the battery.** Exposure to potentially harmful materials may occur.

- f) **In case of fire use CO2 dry chemical extinguisher.**
- g) **Do not expose to high temperatures >50°C.** Cells may degrade at high temperatures.
- h) **The battery must be charged by a constant current, constant voltage transformer.**
- i) **Charge battery regularly in conditions between 5°C to 45°C with the specified charger designed for this battery.**
- j) **Store in a dry, well ventilated area within the recommended limits of 10°C to 30°C.**
- k) **Do not use battery if it has been stored at 5°C or less.** Allow it to "normalise" at room temperature before usage/charging.
- l) **During decommissioning remove the battery cell for recycling separately to the product, which is covered by the waste electrical and electronic equipment directive.** Insulate the terminals with adhesive insulating tape to prevent a short circuit, fire or explosion occurring.

### 5.5 CONNECTION TO THE POWER SUPPLY

**Caution:** Risk of electric shock. Do not open.

Make sure the power supply information on the machine's rating plate are compatible with the power supply you intend to connect it to.

This product comes supplied with a UK standard 3 pin plug fitted. It is designed for connection to a domestic power supply rated at 230V AC.

This appliance is Class II and is designed for connection to a power supply matching that detailed on the rating label and compatible with the plug fitted.

If an extension lead is required, use an approved and compatible lead rated for this appliance. Follow all the instruction supplied with the extension lead.

†Double insulated : This product requires no earth connection as supplementary insulation is applied to the basic insulation to protect against electric shock in the event of failure of the basic insulation.

Apart from replacing the fuse in the plug, no other electrical work is recommended on this drill.

### 5.6 LITHIUM-ION MATERIAL DATA SHEET

- a. As a substance under normal conditions of use it is not considered a hazard to health. In the event of accidental release, measures to prevent spread must be adhered. Do not contaminate rivers, waterways or drains.
- b. Composition of lithium-manganese, lithium-cobalt and lithium salt as the organic solvent electrolyte (nonaqueous liquid).
- c. Hazardous Decomposition: None during normal operating conditions. If cell is ruptured hydrogen fluoride and carbon monoxide may be released.



## 6. TECHNICAL DESCRIPTION

---

### 6.1 IDENTIFICATION



- |                                 |                                 |
|---------------------------------|---------------------------------|
| ① Variable speed trigger switch | ⑤ 18V 1.5Ah Li-ion battery pack |
| ② Forward/Reverse/Lock selector | ⑥ LED work light                |
| ③ 10mm Keyless chuck            |                                 |
| ④ Torque selection collar       |                                 |

# 7. UNPACKING & CHECKING

---

## 7.1 PACKAGING

Carefully remove the cordless drill from the packaging and examine it for any sign of damage that may have happened during shipping. Lay the contents out and check them against the parts shown below. If any part is damaged or missing; please contact the Draper Help Line (the telephone number appears on the Title page) and do not attempt to use the cordless drill.

The packaging material should be retained at least during the guarantee period: in case the machine needs to be returned for repair.

**Warning!** Some of the packaging materials used may be harmful to children. Do not leave any of these materials in the reach of children.

If any of the packaging is to be thrown away, make sure they are disposed of correctly; according to local regulations.

## 7.2 WHAT'S IN THE BOX?

As well as the cordless drill; there are several parts not fitted or attached to it.



- ⑦ Spare 18V 1.5Ah Li-ion battery pack.
- ⑧ 18V 3 – 5 hr adaptor charger.
- ⑨ Double ended screwdriver bit (No.2 cross slot/5.5mm plain slot).

## 8. BASIC CORDLESS ROTARY DRILL OPERATIONS

### 8.1 BATTERY CHARGING – FIGS. 1 – 2

To charge the battery pack (5), it must first be removed from the drill.

- (i) To release the battery pack, press down on the battery release button (5.1) located on the front of the battery pack and gently pull the battery pack away from the housing (Fig.1).
- (ii) Slide the charger connector (8) onto the connection block of the battery pack (5) and then the charger's three pin plug into a 230V. electrical socket.
- (iii) The red LED (8.2) on the charger will illuminate solid and the green LED (8.1) will extinguish to show that the battery is charging.

The battery will be fully charged after the 3-5 hour charging period. The red LED will no longer illuminate and the green LED will illuminate solid.

The battery pack and charger can then be separated and removed from the 230V supply. To refit the battery pack to the drill, push firmly until the battery pack locates and clips into place.

**Warning:** Do not exceed charging period this could damage the battery. Overcharging the battery (more than six hours) could damage the battery cells.

**Note:** The battery was discharged after manufacturing and will therefore require five to ten charges/discharges before it reaches its full capacity. Do not expose either the drill or charger to rain or water.

### 8.2 DUST AND SWARF

A correctly fitted dust mask, suitable for the activity and in accordance to the relevant standard must be worn.

Swarf produced by metal drilling is extremely sharp. Take precautions when clearing swarf. The burr left on the hole is also sharp and should be removed with a suitable tool.

Always wear safety goggles.

**Warning:** Drill bit will be hot after use.

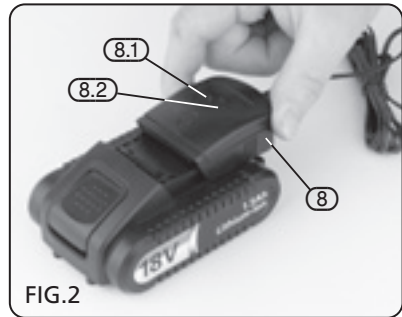
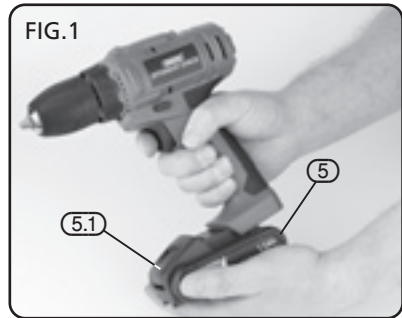

## 8. BASIC CORDLESS ROTARY DRILL OPERATIONS

### 8.3 INSTALLING AND REMOVING BITS – FIG. 3

The drill is fitted with a keyless chuck (3), this means that a chuck key is not required to secure the drill or screwdriver bit.

- (i) Place the drill bit shoulder into the chuck as far as it will go.
- (ii) Tighten the chuck firmly.

**Note:** Short screwdriver bits need only be inserted to the depth of the hexagon shank before tightening chuck by hand.



### 8.4 LED WORK LIGHT – FIG. 4

To aid drilling and screwdriving in confined, inadequately lit spaces, the LED work light (6) automatically illuminates when the trigger is activated.

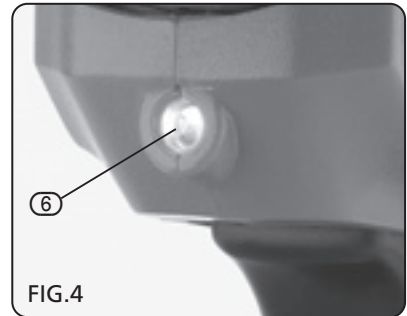

### 8.5 FORWARD/REVERSE SELECTOR – FIG. 5

The forward/reverse selector switch determines the direction of rotation of the chuck, i.e. clockwise or anticlockwise.

- (i) Stop the drill and push switch (2) to the left or right.

**Note:** When the direction switch is pushed to the left, the chuck will rotate clockwise.

When the switch is pushed to the right, the chuck will rotate anticlockwise. Before operation, check that the switch is set in the required position. Do not change the direction of rotation until the chuck comes to a complete stop.

- (ii) When the drill is not in use move the direction switch to the neutral position (the middle setting) to lock the trigger out. This will help prevent accidental drill operation and drill burn-out situations.

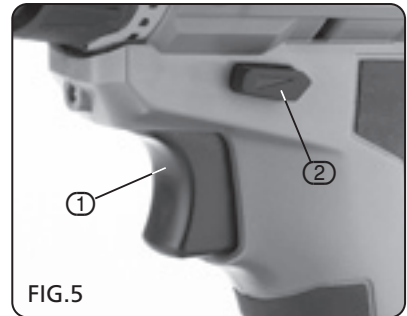

### 8.6 VARIABLE SPEED TRIGGER – FIG. 5

When the trigger (1) is depressed, the chuck will rotate (provided the direction switch is set in the forward or reverse position). This trigger switch is electronic which enables the user to vary the speed continuously. The speed varies according to how far the trigger switch is depressed. The further it is depressed, the faster the chuck will rotate. The lighter it is depressed, the slower it will rotate.

## 8. BASIC CORDLESS ROTARY DRILL OPERATIONS

### 8.7 TORQUE CONTROL – FIG. 6

By turning the collar (4) it is possible to adjust the amount of torque.

- (i) In the "twist drill" setting , the drill/screwdriver has full torque. This is set for optimum drilling.
- (ii) Settings 1-21 provide a facility for setting the torque to the required level. For example, this means that repetitive driving of screws of the same size will be driven into the material to the same torque, thus giving the same fixing strength, or in the case of countersunk screws, these will all be driven to the same depth in the material.

The torque control prevents the heads of small diameter screws being twisted off when correctly set.

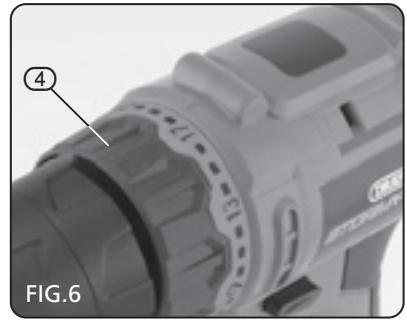

### 8.8 HOLDING THE DRILL – FIGS. 7 – 8

The drill casing is designed to be held comfortably in two ways, as shown.



## 8. BASIC CORDLESS ROTARY DRILL OPERATIONS

---

### **8.9 DRILLING WOOD AND PLASTIC**

To prevent splitting around the drill holes on the reverse side, place a piece of scrap timber under the material to be drilled.

### **8.10 DRILLING METAL**

Metals such as sheet steel, aluminium and brass may be drilled. Mark the point to be drilled with a centre punch to help the drill bit tip to locate. A drop of oil on the area will aid cutting and help prolong the life of the bit.

### **8.11 SCREWDRIVING**

To prevent slip or damage to the screw head, match the screwdriver bit to the screw head size. To remove screws, move the direction switch to the reversing position and apply pressure to the screw head and depress the trigger slowly).

Screwdriver bits are consumable items.

**Note:** Before drilling, check that there are no hidden hazards such as electrical cables, water or gas pipes running below the surface use a metal/voltage detector.

## 9. MAINTENANCE

---

### **9.1 MAINTENANCE**

Regular inspection and cleaning reduces the necessity for maintenance operations and will keep your tool in good working condition. The motor must be correctly ventilated during tool operation. For this reason avoid blocking the air inlets. After use disconnect the tool from the power supply and vacuum the ventilation slots.

If the cord is damaged the transformer must be scrapped. If the non-self-resetting protective device is activated due to short circuit or an overload the transformer must be scrapped.

## 10. OPTIONAL ACCESSORIES

---

### 10.1 OPTIONAL ACCESSORIES

Stock No.	Part No.	Voltage
17970	CB180SF	18V 1.5Ah Li-ion battery.
17973	C180SF	18V 3 – 5hr Adaptor charger.
17974	C181SF	18V 1hr fast charger.



# 11. TROUBLESHOOTING

---

**Warning:** For your own safety always turn the main switch on the machine "off" before carrying out any maintenance or trouble shooting.

<b>Problem</b>	<b>Cause</b>	<b>Remedy</b>
Drill does not work.	<ol style="list-style-type: none"><li>1. Flat battery.</li><li>2. Forward/Reverse not selected.</li></ol>	<ol style="list-style-type: none"><li>1. Charge battery.</li><li>2. Select forward or reverse.</li></ol>
Chuck does not close or grip.	<ol style="list-style-type: none"><li>1. lock screw loose.</li><li>2. Swarf in chuck.</li></ol>	<ol style="list-style-type: none"><li>1. Open chuck fully and tighten screw (left hand thread).</li><li>2. Clean inside chuck with cleaning fluid.</li></ol>

If you have any other difficulties you can contact our technical helpline for further assistance: 023 8049 4344.

# 12. EXPLANATION OF SYMBOLS

---

## 12.1 EXPLANATION OF SYMBOLS



Class II construction  
(Double insulated).



WEEE  
Do not dispose of Waste Electrical & Electronic  
Equipment in with domestic rubbish



For indoor use only.  
Do not expose to rain.



**Li-ion**

Li-ion battery must be recycled or disposed of properly.

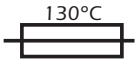

Non-Self-Resetting protective device.



Short-circuit-proof safety isolating transformer.



Polarity indication.



**Warning!**  
Read instruction manuals before  
operating and servicing this  
equipment.



**Warning!**  
Wear safety goggles.

# 13. DISPOSAL

---

## 13.1 DISPOSAL

At the end of the machine's working life, or when it can no longer be repaired, ensure that it is disposed of according to national regulations.

Contact your local authority for details of collection schemes in your area.

In all circumstances:

- Do not dispose of power tools with domestic waste.
- Do not incinerate.
- Do not abandon in the environment.
- Do not dispose of WEEE\* as unsorted municipal waste.



## 13.2 HEALTH AND SAFETY FOR BATTERIES

General: Do not put in fire or mutilate - cells may burst or release toxic materials.

Do not short circuit cells, may cause burns.

The battery must be removed from the appliance before it is scrapped.

The battery is to be disposed of safely.

## 13.3 DISPOSAL

Do not mutilate batteries, corrosive electrolyte will be released.

Do not incinerate - danger of explosion and release of toxic fumes.

Do not dispose of batteries or cells in a charged condition.

Expired Li-ion batteries must be recycled/disposed of in accordance with the appropriate regulation or legislation. They should be returned to your local warranty agent/stockist.

\* Waste Electrical & Electronic Equipment.

- **DRAPER TOOLS LIMITED,**  
Hursley Road, Chandler's Ford,  
Eastleigh, Hampshire. SO53 1YF. U.K.
- **Help Line:** (023) 8049 4344
- **Sales Desk:** (023) 8049 4333
- **General Enquiries:** (023) 8026 6355
- **Service/Warranty Repair Agent**  
For aftersales servicing or warranty repairs, please  
contact the Draper Tools Help Line for details of an  
agent in your local area.

YOUR DRAPER STOCKIST

RDCH0616

