

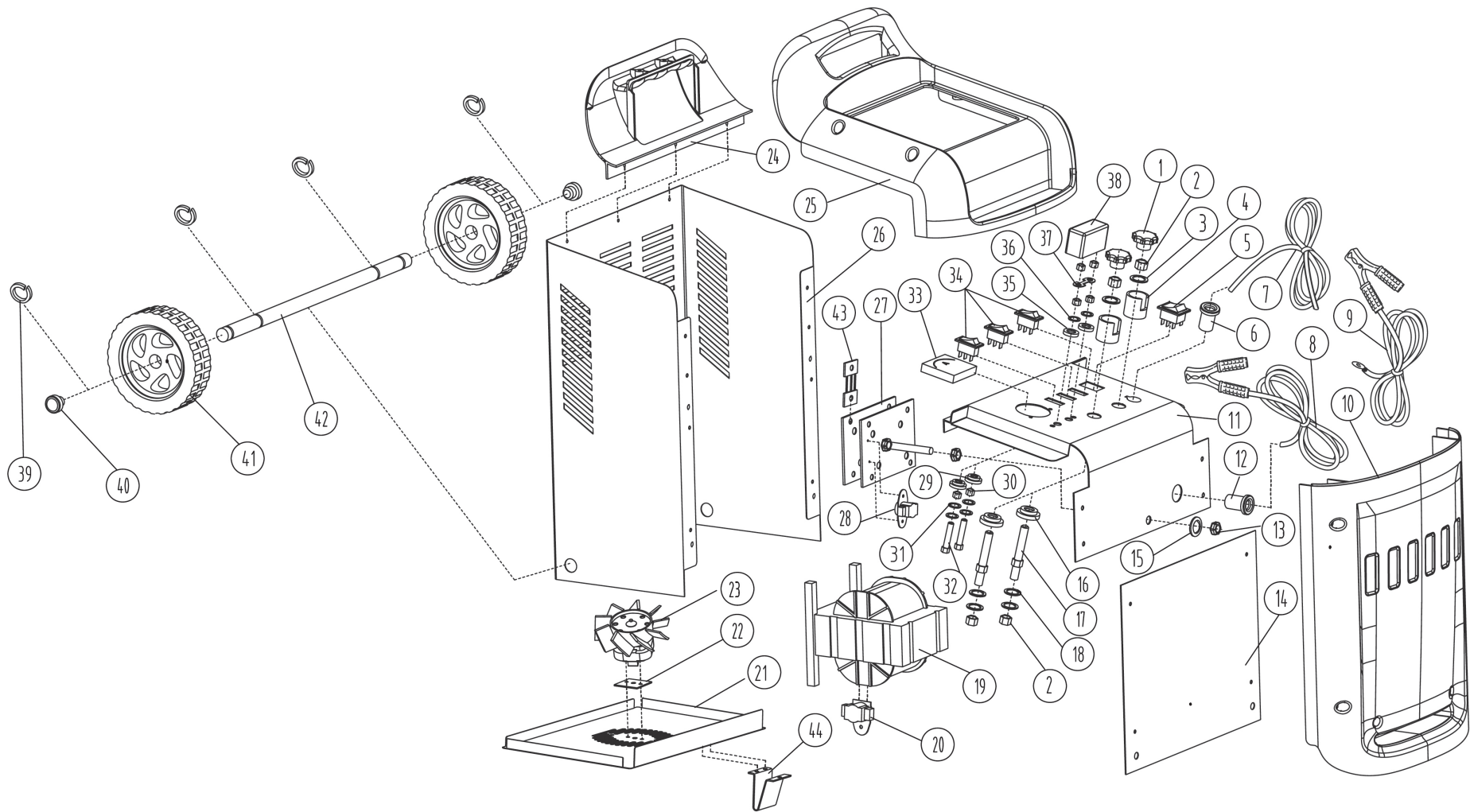

Parts Information:
Starter/Charger 320/45Amp 12/24V 230V
Model No: START320



Sealey Group, Kempson Way, Suffolk Business Park, Bury St Edmunds, Suffolk. IP32 7AR



01284 757500



01284 703534



sales@sealey.co.uk



www.sealey.co.uk



Parts Information:
Starter/Charger 320/45Amp 12/24V 230V
Model No: START320

Item	Part No.	Description
1	START800.01	KNOB
2	SN8.S	STEEL NUT M8 ZINC DIN934 (SINGLE)
3	FWM8.S	FLAT WASHER M8 SINGLE
4	START800.04	TERMINAL PROTECTION COVER
5	START420.05	POWER SWITCH
6	START660.06	CABLE GRIP
7	START420.07	POWER CORD
8	START420.08	NEGATIVE CABLE WITH CLAMP
9	START660.09	POSITIVE CABLE WITH CLAMP
10	START320.10	FRONT PLASTIC PANEL
11	START320.11	TOP PANEL
12	START660.12	CABLE GRIP
13	SN8.S	STEEL NUT M8 ZINC DIN934 (SINGLE)
14	START420.14	COVER PANEL
15	START800.15	SERRATED WASHER 8
16	START800.16	INSULATING WASHER
17	START800.17	TERMINAL BOLT M8
18	FWM8.S	FLAT WASHER M8 SINGLE
19	START320.19	TRANSFORMER
20	START320.20	THERMOSTAT (FOR TRANSFORMER)
21	START420.21	BOTTOM PANEL
22	START420.22	INSULATING PLATE
23	START420.23	FAN

Item	Part No.	Description
24	START800.24	HANDLE SUPPORT PANEL
25	START800.25	TOP PLASTIC COVER
26	START420.26	BACK PANEL
27	START320.27	RECTIFIER
28	START320.28	THERMOSTAT (FOR RECTIFIER)
29	START800.29	INSULATING WASHER (A)
30	SN6.S	STEEL NUT M6 ZINC DIN934 (SINGLE)
31	FWM6.S	FLAT WASHER M6 SINGLE
32	SS635.S	HEX HEAD SET SCREW M6x35mm SINGLE
33	START420.33	AMMETER
34	START420.34	SWITCH
35	START800.35	INSULATING WASHER (B)
36	FWM6.S	FLAT WASHER M6 SINGLE
37	START.F	FUSE (SINGLE) 110A
--	START.20F	FUSE (PACK OF 20) 110A
38	START800.38	FUSE BOX
39	SWM12.S	SPRING WASHER M12 ZINC (SINGLE)
40	START800.40	AXLE CAP
41	START800.41	WHEEL
42	START800.42	WHEEL AXLE
43	START660.43	SHUNT
44	START800.44	FOOT

NOTE: It is our policy to continually improve products and as such we reserve the right to alter data, specifications and component parts without prior notice.

IMPORTANT: No liability is accepted for incorrect use of product.

WARRANTY: Guarantee is 12 months from purchase date, proof of which will be required for any claim.

Sealey Group, Kempson Way, Suffolk Business Park, Bury St Edmunds, Suffolk. IP32 7AR



01284 757500



01284 703534



sales@sealey.co.uk



www.sealey.co.uk